



KS20T

HIGH EFFICIENCY MULTICRYSTAL PHOTOVOLTAIC MODULE

TYPICAL OUTPUT 20 Wp



HIGHLIGHTS OF KYOCERA PHOTOVOLTAIC MODULES

Kyocera's advanced cell processing technology and automated production facilities have produced a highly efficient multicrystal photovoltaic module.

These cells are encapsulated between a tempered glass cover and an EVA pottant with PVF back sheet to provide maximum protection from the severest environmental conditions.

The entire laminate is installed in an anodized aluminium frame to provide structural strength and ease of installation.

■ Electrical Specifications

Nominal Power (NP)	20 Wp
Voltage @ NP	17,4 V
Current @ NP	1,16 A
Open Circuit Voltage	21,7 V
Short Circuit Current	1,26 A

■ Physical Specifications

Length	520 mm
Width	352 mm
Depth	22 mm
Weight	2,40 Kg

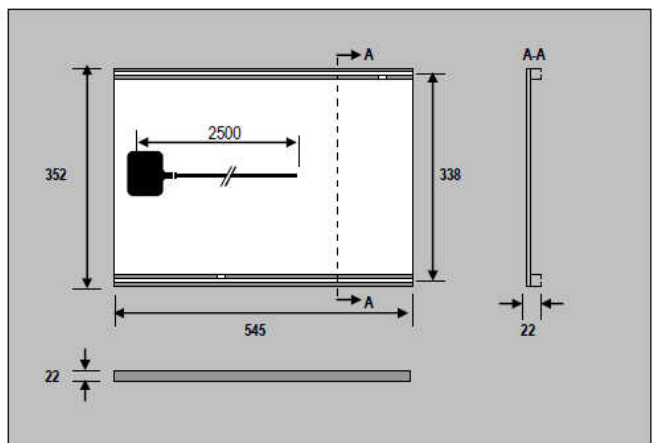
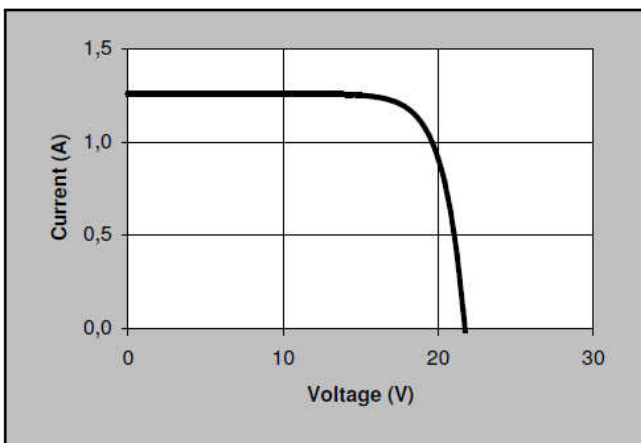

The electrical specifications are under test conditions of irradiance of 1 kW/m², Spectrum of 1.5 air mass and cell temperature of 25°C.
Minimum Power Output = Nominal Power - 10 %

All the distances are in mm.